

MOLICIL High Power LED

KAWA-E-W-L-01-E-K14 Data Sheet

Features

- ◆ Hight Luminous Efficacy 1W White LED
- ◆ Dimension: 14.5mm×8mm×6.0mm
- ◆ Viewing angle: 120 deg
- ◆ The InGaAlN chip inside
- ◆ Low thermal resistance
- ◆ Lead(Pb) free and RoHS compliant
- ◆ Driver currents: 350mA
- ◆ Available in white (4,500 K to 10,000 K CCT)
- ◆ Lumen maintenance of great than 70% after 50,000 hours

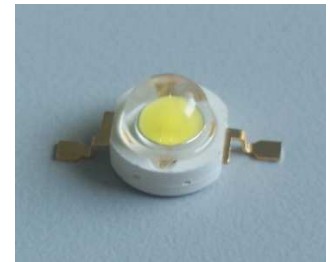

Applications

- ◆ Street lighting
- ◆ Automotive lighting
- ◆ Gerenal lighting
- ◆ Indoor and outdoor architectural lighting
- ◆ Signage and channel letter

Package outline

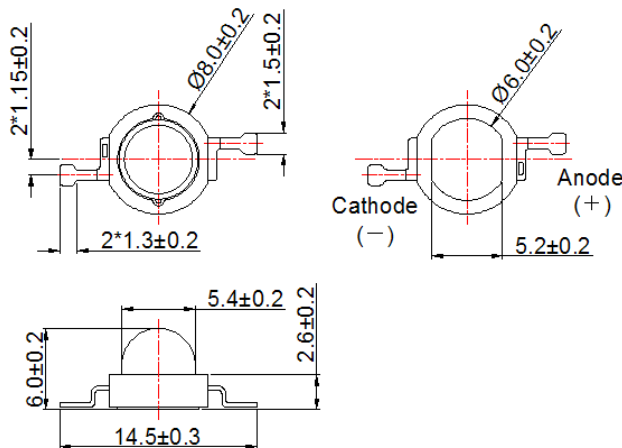

Notes:

1. All dimensions are in millimeters.
2. All tolerance is ± 0.20 mm unless otherwise noted.

Product Nomenclature

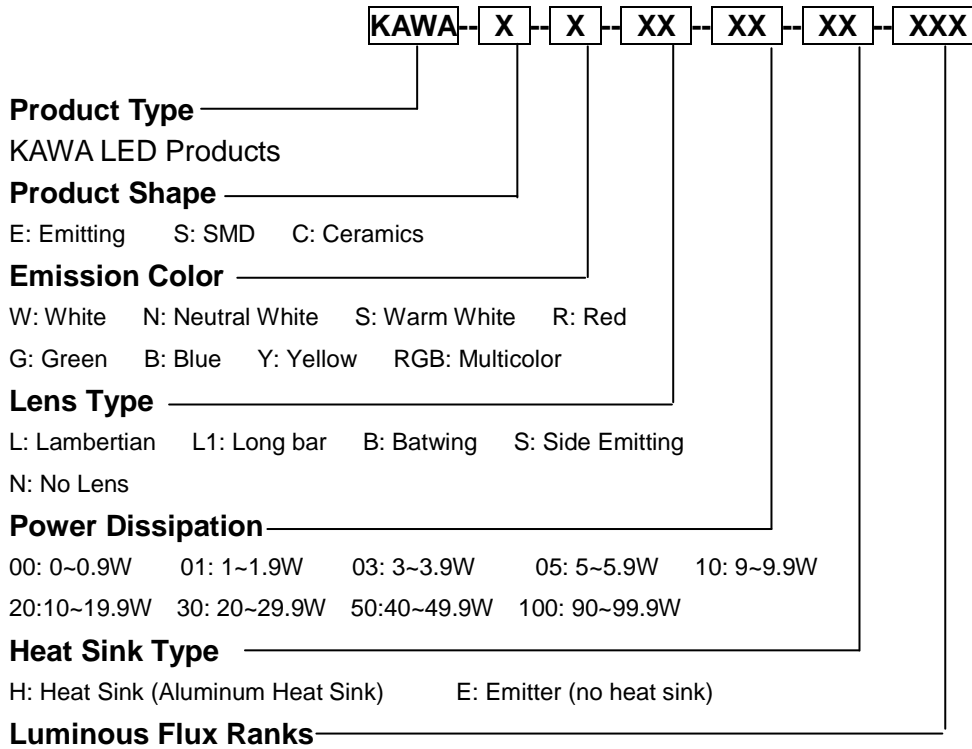

Table 1

Bin Code	Min Flux (Lm)	Max Flux (Lm)	Bin Code	Min Flux (Lm)	Max Flux (Lm)
K01	10.0	13.0	K19	200	220
K02	13.0	16.7	K20	220	250
K03	16.7	21.6	K21	250	300
K04	21.6	27.8	K22	300	400
K05	27.8	35.9	K23	400	500
K06	35.9	44.9	K24	500	600
K07	44.9	52.5	K25	600	700
K08	52.5	60	K26	700	800
K09	60	70	K27	800	900
K10	70	80	K28	900	1000
K11	80	90	K29	1000	1100
K12	90	100	K30	1100	1200
K13	100	110	K31	1200	1400
K14	110	120	K32	1400	2000
K15	120	140	K33	2000	2500
K16	140	160	K34	3000	3500
K17	160	180	K35	6000	7000
K18	180	200			

Absolute Maximum Rating

Parameter	Symbol	Value	Units
DC Forward current	I_F	400	mA
Peak Plused Current (@1kHz ,10% duty cycle)	I_{FP}	500	mA
Reverse Voltage	V_R	5	V
Junction Temperature	T_J	145	°C
ESD Classification (HBM)	---	Class 2	---
Storage Temperature	Tstg	-40~+ 110	°C
Operating Case Temperature	Topr	-40~+ 110	°C
Soldering Temperature	Tsol	260	°C

Notes:

1. Proper current derating must be observed to maintain junction temperature below the maximum.
2. LEDs are not designed to be driven in reverse bias.

Characteristics @ Tc=25°C

Parameter	Symbol	Min.	Typ.	Max.	Units
Viewing Angle	$2\theta_{1/2}$	---	120	---	Degree
Luminous Flux(@350mA)	Φ	110	---	---	lm
Forward Voltage(@350 mA)	V_F	---	3.3	3.6	V
Correlated Color Temperature	CCT	---	6300	---	K
Chromaticity Coordinates	x,y	---	0.32,0.33	---	---
Thermal Resistance Junction-case	$R_{\theta J-C}$	---	15	---	°C/W

Notes:

1. Proper current derating must be observed to maintain junction temperature below the maximum.
2. LEDs are not designed to be driven in reverse bias.
3. Kawa maintains a tolerance of $\pm 10\%$ on flux measurements.
4. Kawa maintains a tolerance of $\pm 0.1V$ on forward voltage measurements.
5. CCT $\pm 5\%$ tester tolerance.
6. Typical Color Rendering Index (CRI) is 75

Luminous Flux Bins @350mA

Bin Code	Min.	Typ.	Max.	Units
K13	100	----	110	lm
K14	110	----	120	lm

Cool White Bin

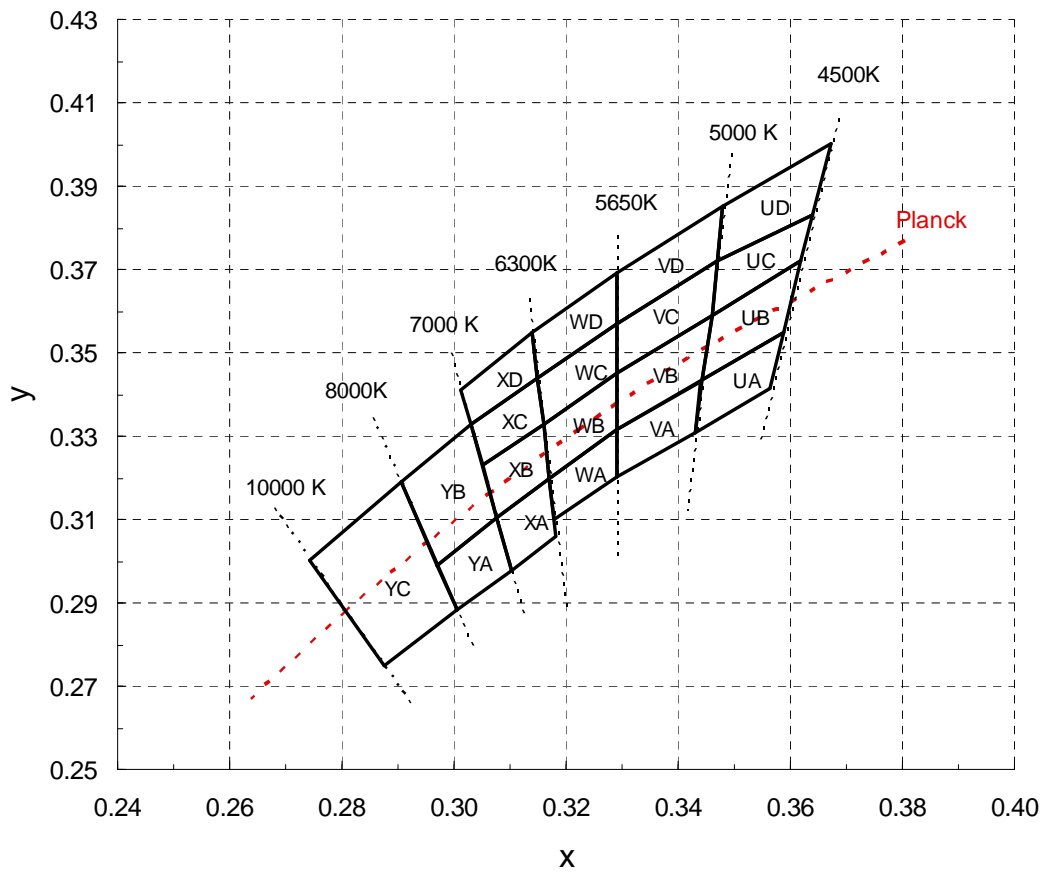

Forward Voltage Bins @350mA

Bin Code	Min.	Typ.	Max.	Units
J	3.0	----	3.2	V
K	3.2	----	3.4	V
L	3.4	----	3.6	V

Package outline

Relative Spectral Power Distribution @ Tc=25°C

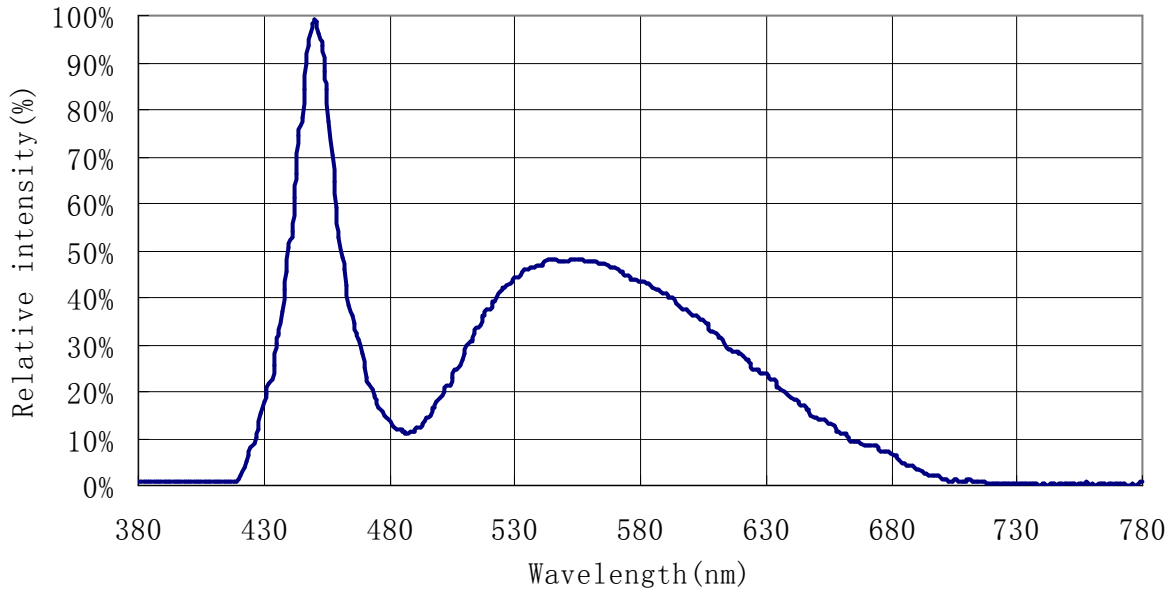

Electrical Characteristics @ Tc=25°C

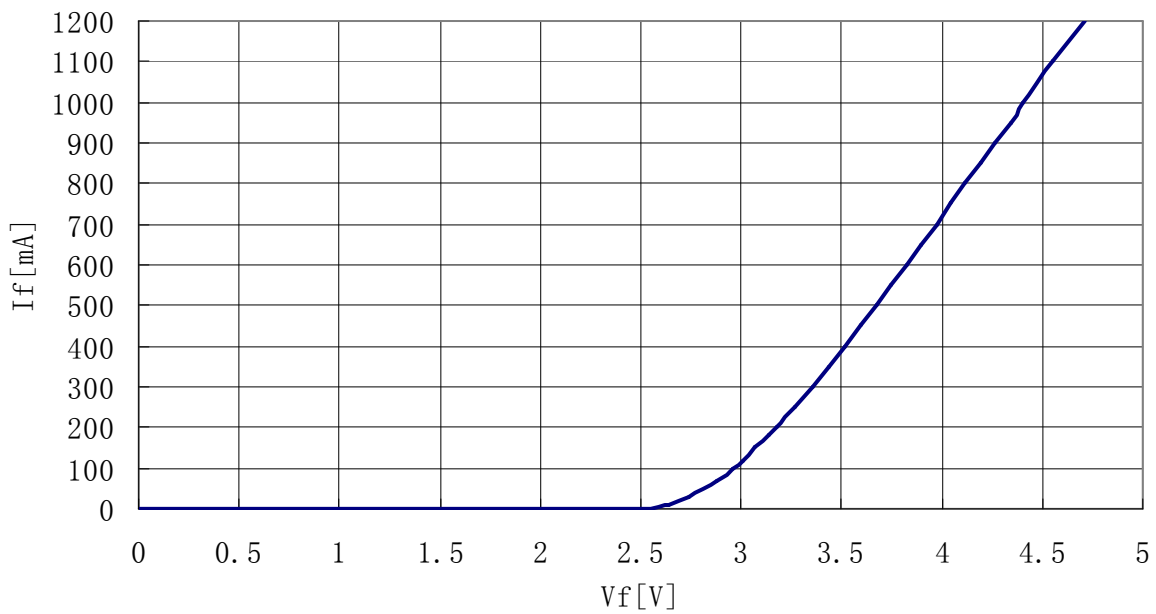

Relative Intensity vs. Current @ Tc=25°C

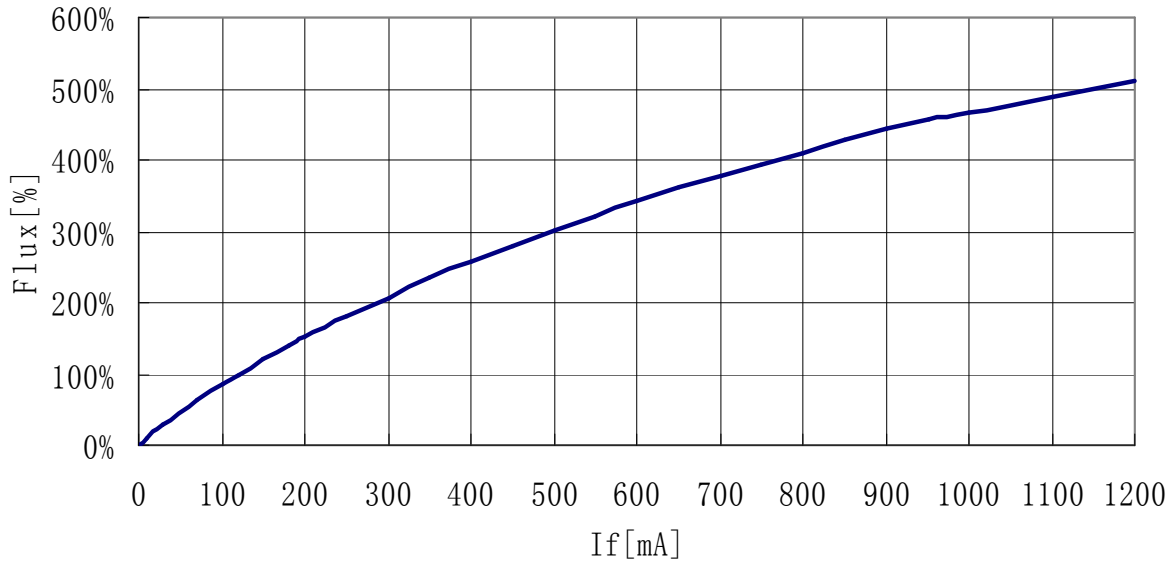

Typical Spatial Radiation Pattern @ Tc=25°C

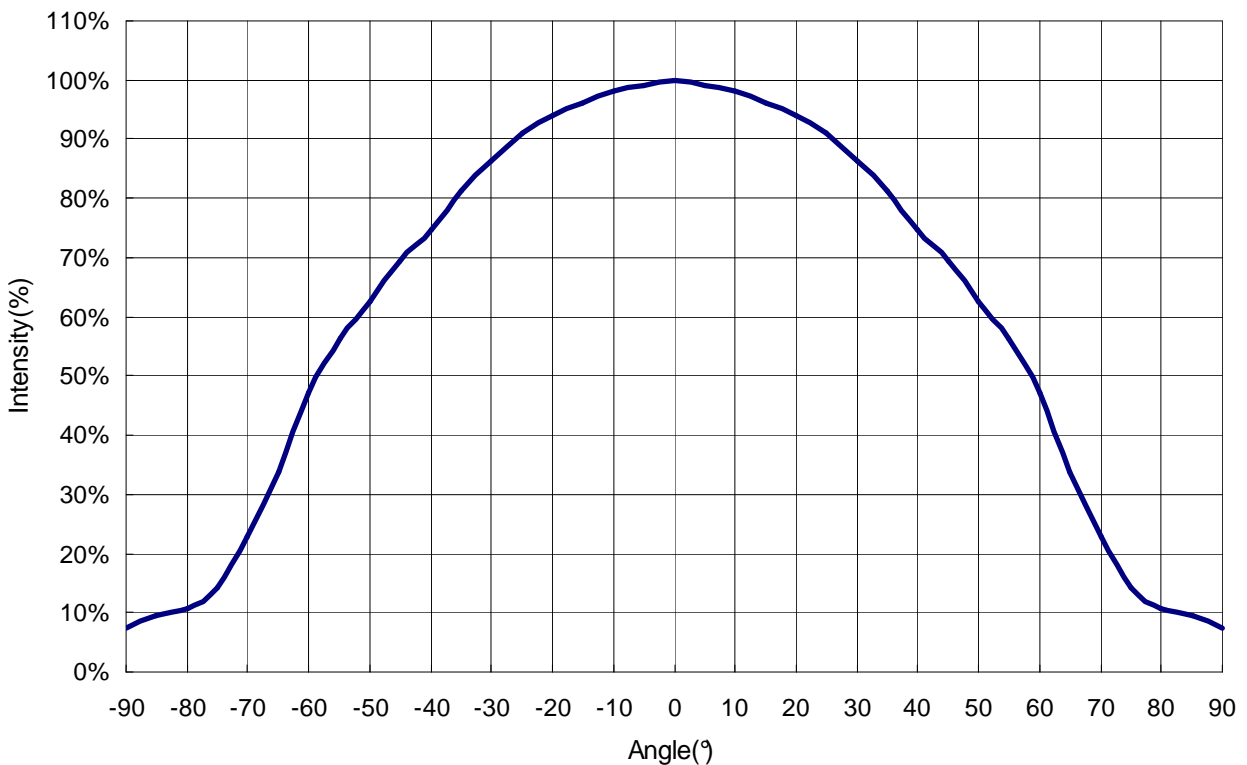

Typical Light Output over Temperature

